

# ICON F4



USER MANUAL

## CONTENT

### 1. Safety Informations

1.1. General Preventive Measures	4
1.2. Regulations for equipment that connects to power mains	5
1.3. Technical warnsigns and explanation	6

### 2. Introduction

2.1. About us	7
2.2. ICON F4	7

### 3. General Product Information

3.1. Scope of delivery	8
3.2. Control Functions	8
3.3. Features	8

### 4. Installation & Setup

4.1 Physical Installation and Rigging	9
4.2 Connections	9
4.2.1. AC Power	10
4.2.2. DMX Connection	10
4.2.2.1. KLSTR	10
4.2.2.2. Wireless Connection	11
4.3 NFC	13

### 5. Operation

5.1 Start up	14
5.2 Control Display	14
5.3 Display Short Cuts	14
5.4 Configuration	16
5.4.1 Set DMX Start Address (Direct Access)	16
5.4.2 Selecting DMX Mode	16
5.4.3 Knob-Operation	17
5.4.4 Stand Alone	18
5.4.5 Settings	25
5.4.5.1 Reset functions	28
5.4.7 System Info	29

### 6. Accessories

6.1. Accessories	30
------------------	----

---

## **7. Technical Data / Diagrams**

---

7.1 Technical drawings and measurements	31
7.2 IP Rating	32
7.3 Technical Data	33
7.4 DMX-Charts / Color Macro Charts / CCT Chart	35
7.5 RDM Templates	39

---

## **8. Troubleshooting**

---

41

## **9. Manufacturer's Declaration**

---

42

## 1. SAFETY INFORMATION

### 1.1. General Preventive Measures

- 1.1.1. Please read, understand and follow the instructions.
- 1.1.2. Store the instructions and information in a safe place.
- 1.1.3. Follow all safety warnings. Under no circumstances remove safety warnings or other information from the equipment.
- 1.1.4. Don't use the equipment for any other intended purpose or manner.
- 1.1.5. Use only stable and compatible stands and/or brackets. Especially when fix installed. Make sure the wall brackets are properly installed and safe. Make sure the device is securely installed and cannot fall.
- 1.1.6. Check the safety regulations applying for your country before and during installation.
- 1.1.7. Keep the device away from heat! Don't place/install near heaters, ovens or any source of heat. Make sure that the device always is efficiently cooled and cannot overheat.
- 1.1.8. Always guarantee that ventilation and cooling slots are clean and not blocked.
- 1.1.9. Item must be away minimum 20cm from anything around and above it.
- 1.1.10. Do not use this device close to water.
- 1.1.11. Do not expose this equipment to flammable materials.
- 1.1.12. Make sure that no objects can fall into the device.
- 1.1.13. Only use this device with the accessories recommended by the manufacturer.
- 1.1.14. Always check the equipment for housing damages, so that no water can enter the device. No containers containing liquids of any kind should be place on top of the unit.
- 1.1.15. Opening or modifying this device is only allowed by authorized and qualified persons.
- 1.1.16. All cables need to be checked after connecting the device in order to prevent damage or accidents.
- 1.1.17. Make sure that the device is transported safe and packed proper in order to prevent damage of any kind.
- 1.1.18. Once you notice improper function of your device due to damage, electric shock or anything similar, immediately unplug the unit from the mains outlet and contact our service department.
- 1.1.19. Clean the device with a dry cloth.
- 1.1.20. Observe all disposal laws applicable in your country. Especially for the packaging.

1.1.21. Plastic bags are not a toy! Keep away from children!

1.1.22. Please note that changes or modifications which are not approved by the party responsible for compliance will void the user's authority to operate the device.

## **1.2 Regulations for equipment that connects to power mains**

1.2.1. If an earthing contact is available in the used power cord, it must be used in combination with an power outlet, providing a protective ground. In no circumstances should the protective ground be deactivated.

1.2.2. Do not switch on the device immediately after it has been in strong different temperatures, especially after transport. Let the device acclimatize to the temperature in the room of usage first to prevent moisture and condensation.

1.2.3. Verify that the correct voltage and frequency are available in the area of operation, before connecting the unit to the mains outlet.

1.2.4. If the plug doesn't fit in your mains outlet, contact your electrician.

1.2.5. Make sure your power cord/adapter/connector does not show signs of kinks/warps or is being stepped on.

1.2.6. Always disconnect the unit when not in use or being cleaned. Don't pull on the cord to disconnect. Only touch power connections with dry hands!

1.2.7. Don't switch the unit on/off rapidly. This may cause damage.

1.2.8. If a fuse needs to be replaced, ALWAYS make sure that exactly the same fuse will be used (type and rating). Repeatedly blown fuses need to be checked by an authorised service technician.

1.2.9. In the risk of lightning strike all units need to be unplugged from the mains in order to prevent damage.

1.2.10. During installation there must be a voltage free condition.

1.2.11. The device needs to be cleaned and serviced regularly and will credit this with a longer life cycle. Dust, dirt, moist, water, smoke, nicotine or anything similar inside the unit will cause damage/malfunction.

1.2.12. The unit needs to have at least 0,5m distance to anything flammable.

1.2.13. You have to make sure that any electrical installation applies to the laws of your country. Correct power cables and applying standards have to be used.

### 1.3. Technical warnsigns and explanation



In order to prevent the risk of an electric shock, under no circumstances remove the cover/back or open the unit in any way! No user serviceable parts are inside. Service, maintenance and repairs should only be done by qualified service personnel or the manufacturer.



Dangerous uninsulated voltage inside the device can cause an electrical shock when opened by unqualified personnel.



Important operating and maintenance instructions apply!



Do not operate this device in tropical climates.



CAUTION! Intense LED light source! Risk of eye damage. Do not look into the light source



The housing surface of the spotlight can heat up to temperatures as high as 70 °C in regular use. Ensure that it is not possible to come into contact with the housing unintentionally. Always allow sufficient time for the lamp to cool down before dismantling, carrying out maintenance work or charging etc..



#### IMPORTANT INFORMATION!

- This is a product which has been developed for professional usage in event technology. It is not suitable as a household lighting.
- NEVER stare, not even temporarily, directly into the light source.
- Don't use magnifiers or any other optical instrument to look at the beam.
- The effects of this device, especially the stroboscope effect, can cause problems for sensitive people or may even cause epileptical seizures.

## 2. INTRODUCTION

### 2.1. About us

*The name ROXX® came easily.*

Combined with the concentrated knowledge and many years of experience, our three founders, who have been leaving their mark in the event and lighting industry for many years already, came together in 2020 to start this outstanding venture.

Product development, sales and marketing as well as the exceptional know-how and the profound rooting in the field of the professional lighting technology belong to our core competences and therefore guarantee extremely innovative and reliable products, excellent support and professional service in every aspect.

*Designed & developed in Germany*

ROXX® products are developed and designed in Germany. Always in tight consultation with our customers and experts who will eventually be working with these tools. This ensures innovative, easy-to-use and performance-oriented solutions, which provide added value for our customers.

*Made to last*

Recommended for permanent outdoor use, most ROXX® products feature additional corrosion protection and enhanced IP66 equipment protection, thereby providing that crucial extra for a wider range of applications. In addition to architectural or theme park applications, even fixed installations in coastal or offshore areas with high salt exposure can be reliably implemented over long periods of time.

### 2.2. ICON F4

The ICON F4 is a compact and versatile solution designed as a true 300W replacement, ideal for applications where size, flexibility, and integration are key. Its 200W 6-in-1 RGBALC LED engine delivers up to 3.100 lumens, offering high-quality color rendering and consistent white light performance (CRI up to 98 / TLCI up to 99). The 100 mm / 4" Fresnel lens ensures a soft and even beam in a compact form factor.

## 3. GENERAL PRODUCT INFORMATION

### 3.1. Scope of delivery

- ⊕ 1x ICON F4
- ⊕ Power cord with plug (EU country specific, if not ordered differently)
- ⊕ 8-way Barndoor

We're offering professional accessories (optional). Please see under chapter 6 or at our website [www.roxxlight.com](http://www.roxxlight.com)

### 3.2. Control Functions

- 1CH Quick, 4CH CCT, 7CH CCT, 6CH RGB, 10CH RGB, 18CH RGB, 12CH DIRECT, 14CH DI-RECT, 21CH DIRECT, 6CH HSI, 12CH HSI
- Stand Alone Functions including cinema effects, various auto programs, customisable scenes, CCT, LEE adjusted color macros and custom color templates (RGBALC)
- Hardware Knobs for direct control of CCT, HSI, RGB, GEL
- Master & Slave (by DMX and Wireless DMX)
- ROXX NFC App - Near Field Communication
- Optional wireless DMX (Lumenradio CRMX®)
- ROXX App - Bluetooth 5.0 (requires the optional wireless DMX upgrade)

### 3.3. Features

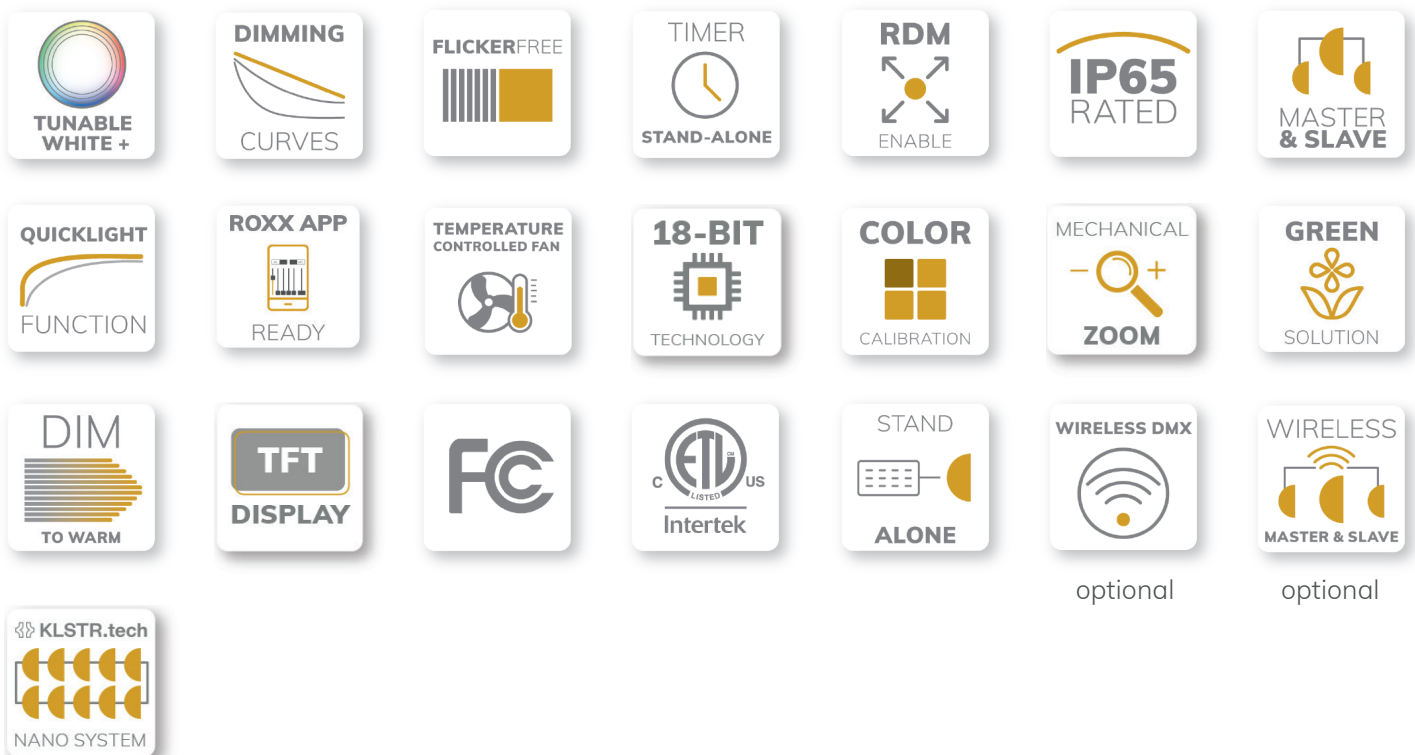

## 4. INSTALLATION & SETUP

### 4.1 Physical Installation and Rigging

ROXX ICON F4 may be installed in any orientation. For this purpose the product provides several options:

#### Hanging:

On top of the yoke, there are three 12 mm holes for mounting the fixture using accessories such as half couplers or hooks. It also features a specially designed TV spigot connection to ensure maximum stability.



### 4.2 Connections\*

**A:** IP65 Power input connector with rubber sealing cap. Connect using the provided power cable (when not in use, always close with rubber sealing cap)

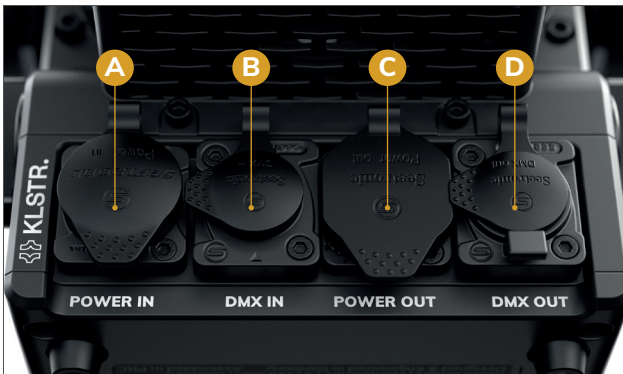

**B:** Female IP65 5-pin XLR connector (when not in use, always close with rubber sealing cap).

**C:** IP65 Power output connector with rubber sealing cap. Provides power to additional fixtures.

Ensure that the total power consumption of all daisy-chained devices connected do not exceed 11A@230V or 7A@100V ! (when not in use, always close with rubber sealing cap).

**D:** Female IP65 5-pin XLR connector (when not in use, always close with rubber sealing cap).



**A:** Zoom indicator

**B:** Mechanical zoom handgrip

**C:** Display with control buttons

**D:** Direct access buttons and rotary control

In order to provide protection from spraying water, in accordance with protection class IP65, special IP65-rated XLR connectors must be used correctly with the DMX input and output sockets, or they must be closed using the rubber sealing caps. When connected correctly, or when sealed correctly with the rubber sealing caps, the POWER IN and POWER OUT sockets are protected from spraying water, as in accordance with IP65.

#### 4.2.1. AC Power

The ICON F4 operates on any 100–240 V, 50/60 Hz AC mains power supply with a maximum power consumption of 623W.

Connect the fixture to AC power using the supplied cable or a similar one with Neutrik powerCON TRUE1 NAC3FX-W or a compatible type, to ensure the correct ingress protection (IP).

For temporary installations, the mains cable must be fitted with a grounded connector intended for exterior use. The fixture must be grounded/earthed and be able to be isolated from AC power. The AC power supply must incorporate a fuse or circuit breaker for fault protection.

Wire Color (EU models)	Wire Color (US models)	Conductor	Symbol
Brown	Black	Live	L
Blue	White	Neutral	N
Yellow / Green	Green	Ground (earth)	⊕ or ⊚



#### Warning!

Read “Safety Informations” starting on page 3 before connecting the fixtures to AC mains power!  
Do not connect the fixture to an electrical dimmer system, as doing so may cause damage that is not covered by the product warranty!

#### 4.2.2. DMX Connection

The ICON F4 is fully controllable by DMX (USITT DMX512-A standard, based on RS-485) and RDM. It can be connected using either DMX cables or via the built-in LumenRadio CRMX wireless system.

##### 4.2.2.1. KLSTR

The KLSTR.nano system supports at least 90 fixtures on a single daisy-chained line while maintaining reliable operation. Signal integrity is preserved for distances up to 400 meters between KLSTR.nano-equipped fixtures, enabling flexible layouts across large venues.

Each KLSTR-enabled fixture regenerates and outputs a fresh DMX stream, so every device functions as the virtual start of a new line and prevents cumulative signal degradation. When used with an Ethernet-to-DMX node that supports ring topology, unaffected sections remain fully operational if a fault occurs.

The system provides immediate identification of faulty cables or fixtures and isolates problems locally to avoid system-wide failure. Operators get a real-time graphical overview of the entire KLSTR.nano chain via the KLSTR.ctrl application. Configuration is streamlined and requires minimal user interaction when performed with KLSTR.ctrl, reducing setup time and simplifying maintenance

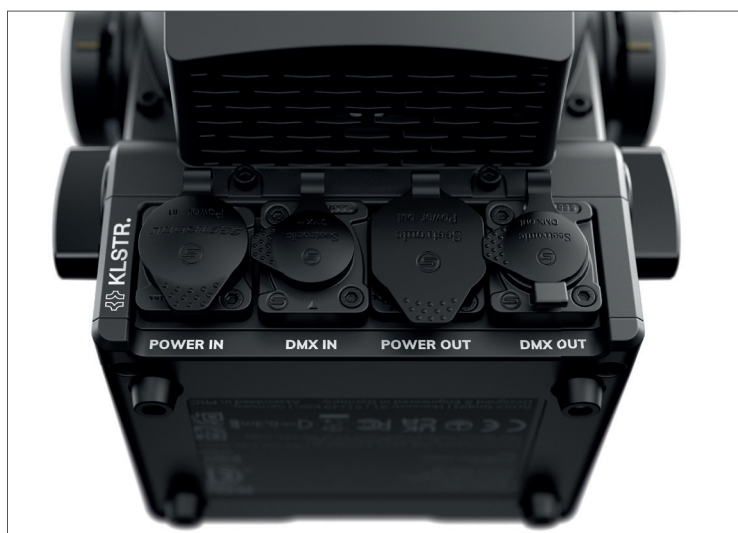

 **KLSTR.tech**

#### 4.2.2.2. Wireless Connection\*

The ICON F4 can be equipped with an optional LumenRadio Transceiver

This enables the fixture to work with the following connectivity options:

- ⊖ Working in Receiver Mode: receive wireless DMX- and RDM Signals via CRMX
- ⊖ Working in Transmitter Mode: transmit DMX (1 universe) to other units via CRMX
- ⊖ Full Control via Bluetooth 5.0 and ROXX App

The fixture is able to send DMX-data received by CRMX or Bluetooth to its physical DMX-Output XLR Connector and hereafter, plugged in by cable, to any DMX-capable unit. For this please enable "Pass to DMX Out" inside Wireless DMX Settings.

ICON F4 can act as a fully operative CRMX Receiver and can be paired to an active wireless transmitter (CRMX) simultaneously as being connected to a cabled DMX. The device will prioritize cabled DMX input over wireless DMX and over Bluetooth. A small indicator in front of "DMX", "CRMX" or "BLE" gives an easy overview which protocol is currently active. Please see the display graphics below.

If using a wireless DMX system, ensure that the DMX input and the DMX output are properly sealed. Connect both DMX IN and DMX OUT, or seal, in order to maintain the fixture's IP65 rating.

ⓘ **\*Note: If you are using XLR for DMX and not Bluetooth we recommend to not connect to Bluetooth unless you need to since it can cause a few dropped DMX packets.**

**BLE and CRMX RX are not available simultaneously.**

- If CRMX RX is enabled and BLE will be enabled after, CRMX automatically changes to TX mode.
- If CRMX TX operating mode is changed to RX, BLE will be disabled automatically.



CRMX	Disabled	The indicator in front of "DMX" shows that DMX is active.
Operation Mode	n.a.	
Linked	No	
Receive Reset	No	
DMX	<b>Enabled</b>	
BLE (Bluetooth)	Disabled	



CRMX	<b>Enabled</b>	The indicator in front of "CRMX (RX)" shows that the fixture is now working in wireless DMX receive mode.
Operation Mode	<b>RX</b>	
Linked	<b>No</b>	
Receive Reset	Yes	"(RX)"= CRMX operating mode is set to receive
DMX	Disconnect	
BLE (Bluetooth)	Disabled	

4.2.2.2. Wireless Connection\*

18 CH RGB

**1**  
Next  
( 19 )

• CRMX(TX) DMX

CRMX	Enabled
Operation Mode	TX
Linked	No
Receive Reset	Yes
DMX	Disconnect
BLE (Bluetooth)	Disabled

The indicator in front of "CRMX (TX)" shows that the fixture is now working in wireless DMX transmit mode.

"(TX)"= CRMX operating mode is set to transmit

18 CH RGB

**1**  
Next  
( 19 )

• CRMX(RX) DMX

CRMX	Enabled
Operation Mode	RX
Linked	Yes
Receive Reset	Yes
DMX	Disconnect
BLE (Bluetooth)	Disabled

Once the fixture is linked to an external transmitter, the CRMX signal-symbol appears on upper left side.

1 dash= 1-30% signal strength  
2 dashes= 31-70% signal strength  
3 dashes= 71-100% signal strength

18 CH RGB

**1**  
Next  
( 19 )

• CRMX(TX) DMX

CRMX	Enabled
Operation Mode	TX
Linked	Yes
Receive Reset	Yes
DMX	Disconnect
BLE (Bluetooth)	Disabled

Once the fixture is linked to an external transmitter, the CRMX signal-symbol appears on upper left side.

1 dash= 1-30% signal strength  
2 dashes= 31-70% signal strength  
3 dashes= 71-100% signal strength

18 CH RGB

**1**  
Next  
( 19 )

• CRMX(RX) DMX

CRMX	Enabled
Operation Mode	RX
Linked	Yes, out of range
Receive Reset	Yes
DMX	Disconnect
BLE (Bluetooth)	Disabled

In case the external transmitter is switched off or out of signal range the signal-symbol starts to blink.

18 CH RGB

**1**  
Next  
( 19 )

• CRMX(RX) DMX

CRMX	Enabled
Operation Mode	RX
Linked	Yes, but no DMX
Receive Reset	Yes
DMX	Disconnect
BLE (Bluetooth)	Disabled

An exclamation appears and blinks although the external transmitter is switched on and is inside the signal range but no DMX is connected to the external transmitter.

18 CH RGB

**1**  
Next  
( 19 )

• BLE DMX

CRMX	Disabled
Operation Mode	n.a.
Linked	No
Receive Reset	No
DMX	Disconnect
BLE (Bluetooth)	Enabled + Paired

The indicator in front of "BLE" shows that the fixture is now working in Bluetooth mode and is paired to ROXX App.

### 4.2.2.2. Wireless Connections

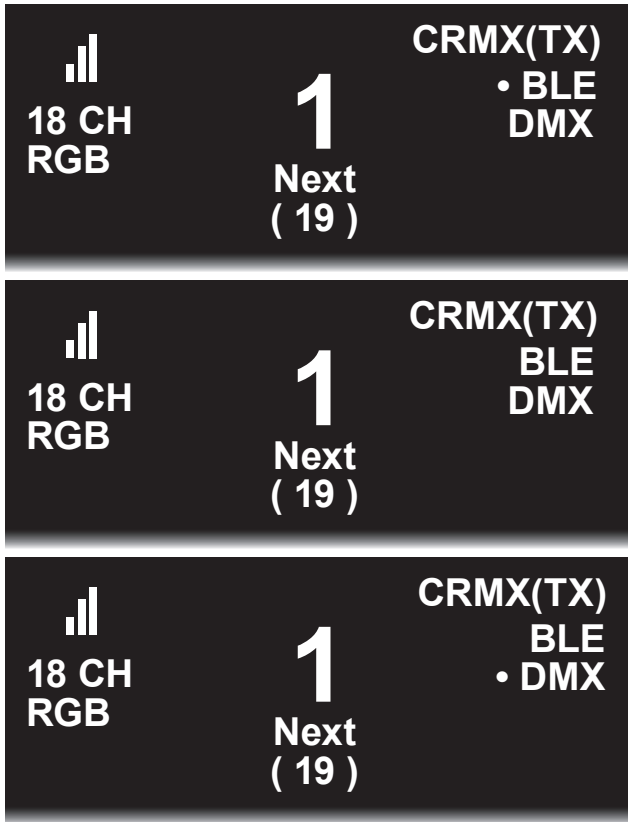

CRMX	Enabled	The indicator in front of "BLE" shows that the fixture is now working in Bluetooth mode and is paired to ROXX App.
Operation Mode	TX	
Linked	Yes	
Receive Reset	No	As CRMX TX is enabled and linked a full DMX universe is send out by CRMX (wireless DMX).
DMX	Disconnect	
BLE (Bluetooth)	Enabled + Paired	

CRMX	Enabled	No indicator in front of "BLE", fixture is not paired to ROXX App.
Operation Mode	TX	
Linked	Yes	
Receive Reset	No	
DMX	Disconnect	
BLE (Bluetooth)	Enabled, not paired	

CRMX	Enabled	DMX is active. As CRMX TX is enabled and linked a full DMX universe is send out by CRMX (wireless DMX).
Operation Mode	TX	
Linked	Yes	
Receive Reset	No	
DMX	Connect	
BLE (Bluetooth)	Enabled	

### 4.3. NFC (Near Field Communication)

ICON F4 integrates a NFC chip (Near Field Communication) and allows in conjunction with ROXX NFC App to address and configure the fixtures wirelessly even when the fixture power is not prevent. Additionally, the fixtures firmware and settings can be read out.

The NFC chip is based on the upper part of the case which ensures easy access when storing. To get a proper connection between your mobile phone and ICON F4, please make sure that your phone is very close to the NFC.

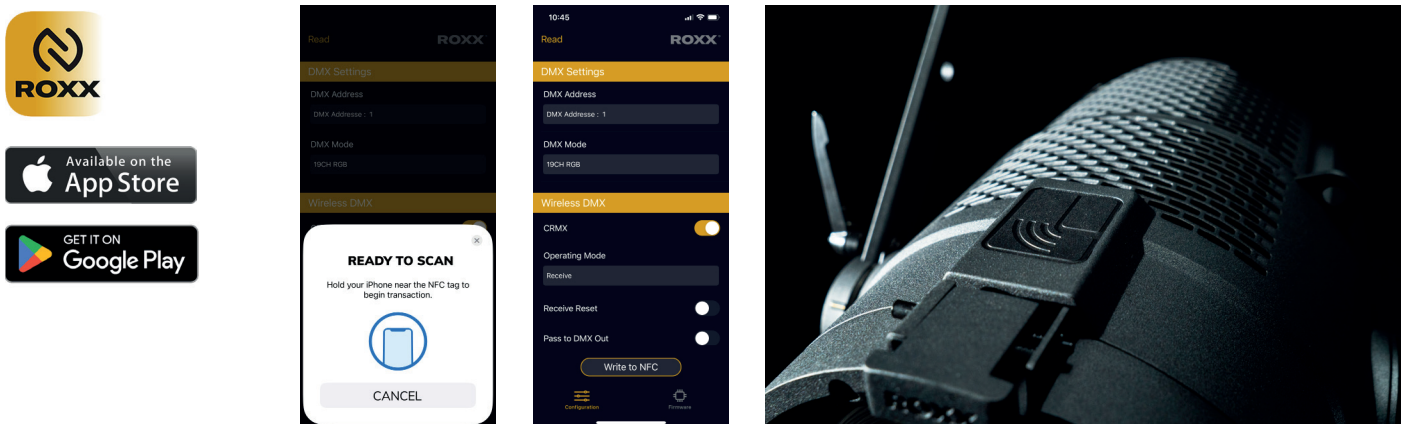

## 5. OPERATION

### 5.1 Start up\*

Once the fixture is connected to AC power, the boot process starts and the following information will appear on the display:

“Ready to ROXX”, the product name and the current software version.



After this process, the fixture is ready for operation, and starts in the previously enabled mode.

**\*Note:**

During boot process the fan spins up quickly to blow out some possible dust from last use.

### 5.2 Control Display\*

ENTER

Press **ENTER** to access the selection menu for system settings or confirm changes.

ESC

Press **ESC** to take a step back in the menu.

▲ ▼

Press **arrows to scroll up and down** inside the menu and change values, such as DMX address.

**\*Note:**

After approximately 1 minute of inactivity inside the menu settings, the display will automatically jump back to home screen.

### 5.3 Display Short Cuts\*

Short Cuts

For some always recurring functions the fixture allows quick and user-friendly access at home screen over some display control short-cuts:

#### User Reset or Factory Reset\*

ENTER + ESC

Pressing **ESC+ENTER** simultaneously a Factory Reset or User Reset can be started.

By using the up/down arrows the Factory- or User Reset can be selected.

For confirming press **ENTER**, to jump back please press **ESC**.

**\*Note:**

For detailed information about the different reset options please refer to chapter "5.4.6.1 Reset functions"

### Display Off



Pressing ESC + arrow down simultaneously the display backlight function will set to off and the display will turn off immediately. Once a control is pressed the display backlight will turn on.

### BLE enabled / disabled



Pressing ESC + Arrow Up simultaneously the Bluetooth will enabled or disabled. Confirm by pressing ENTER, step back by pressing ESC.

### Manual display flip function\*



The fixture includes an auto display flip function by default.

To use the manual display flip function please disable the auto flip function under Settings / Display first. Once the auto display flip function is disabled you can use the manual display flip function by pressing arrow up + arrow down simultaneously. The display will rotate 180. By pressing both arrows simultaneously again the display will flip back.

#### \*Note:

**Once the display is flipped both Up / Down controls will work according to the display rotation.**

## 5.4 Configuration

### Home Screen

After boot process the fixture is ready for operation and starts in the previously enabled mode. At home screen the following information will appear, depending on the current operating mode:

- A** DMX Adress
- B** Operating Mode (DMX Mode, Quick Light or Standalone Mode)
- C** Next available DMX address depending on the fixtures DMX footprint
- D** External Data protocol (CRMX, DMX, BLE).
- E** CRMX status and strength
- F** The dot indicates the active protocol

Note:

**CRMX (RX)** CRMX Receiving Mode

**CRMX (TX)** CRMX Transmit Mode

**BLE** Bluetooth enabled

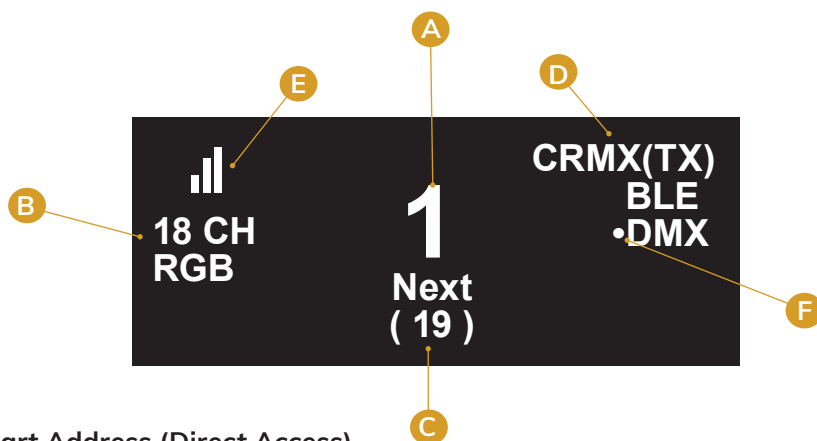

#### 5.4.1 Set DMX Start Address (Direct Access)

At Home Screen the DMX address can be changed directly by using the up and down arrows. During this process the DMX address starts blinking, once it's confirmed by pressing ENTER it stops blinking.

If the DMX address will not be confirmed by ENTER within 10 seconds, the display will jump back and show the DMX address from before and stops blinking.

#### 5.4.2 Selecting DMX Mode\*

At home screen please press ENTER to access to the main menu (level 1).

While using UP / DOWN arrows, please select the menu item "DMX Mode" and confirm by pressing ENTER.

In the following sub-menu (level 2), you can now choose between 10 different DMX operating modes while using the UP/Down arrows and confirm by pressing ENTER or jump back by pressing ESC.

After confirmation the display will jump back to main menu (level 1). Press ESC for homescreen, here the selected DMX mode will be displayed.

#### **ⓘ \*Note:**

**For detailed information about the several DMX modes including channel assignment please see our DMX Control chart.**

Level 1

Menu
➔ DMX Mode
Stand Alone
Slave
Settings
System Info

Level 2

DMX Mode
➔ 1CH Quick,
4 CH CCT
7 CH CCT
6 CH RGB
10 CH RGB
<b>18 CH RGB (Default)</b>
12 CH DIRECT
14 CH DIRECT
21 CH DIRECT
6 CH HSI
12 CH HSI

### 5.4.3 Knob Operation

Using the three knobs and four direct user controls on the units sideplate it's possible to control the fixture completely without a console and directly without entering any menu.

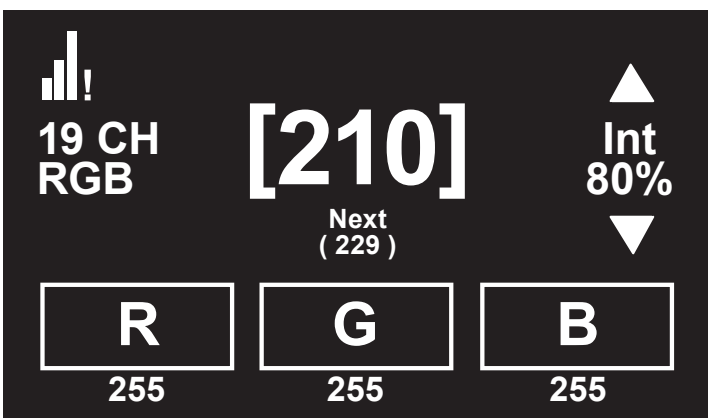

Press the respective user button to choose the desired stand alone function. The display will now show the assigned functions for every encoder. CCT provides a CTC range between 2000K to 10000K. You can also use the RGB or HSI mode to mix any color you need. Palette provides a selection of the fixtures internal color presets and LEE-filter-emulations.

When using the 1-channel Quick DMX mode, the fixture uses the DMX value to control the dimmer of the selected quick access. The default setting is CCT, and DMX always has higher priority than the knob setting.

The knob operates continuously when no external control is active or when 1-channel Quick DMX mode is selected. When a DMX signal is present, it can be overridden via Quick Access for 20 seconds and serves a quick light function. After that, the fixture returns to the DMX values, or to DMX Hold if the signal is lost during that time. Please note, that DMX, CRMX & Bluetooth always have priority before the functions of these knobs.

#### 5.4.4 Stand Alone\*

Press ENTER to access to main menu (level 1).

While using the UP / DOWN arrows, please select the menu item "Stand Alone" and confirm by pressing ENTER.

In the following sub-menu (level 2), you can now choose between 6 different Stand Alone operating modes (Auto, Editor, Color Macro, Quick Color, Tunable White, User Color) ,Stop Stand Alone, Timer and Color Settings functions while using the UP/Down arrows and confirm by pressing ENTER or jump back by pressing ESC.

To finally use Stand Alone programs please make sure either DMX, CRMX RX or BLE is connected to the fixture, as these protocols have priority.

#### Stop Stand Alone

To stop a running Stand Alone mode immediately, please select "Stop Stand Alone" and confirm by pressing ENTER. The display will automatically jump back to level 1.

Level 1

Menu
DMX Mode
█ Stand Alone
Settings
System Info

Level 2

Stand Alone Mode
█ Stop Stand Alone
Auto
Editor
Color Macro
Quick Color
Tunable White
User Color
Timer
Color Settings

#### Auto\*

Select "Auto" by using the up/down arrows and press ENTER.

Here at sub-menu (level 3), you can choose between 10 different Auto Programs

(7-Color Fade, 7-Color Jump, 15-Color Fade, 15-Color Jump, Police RB, Police B, Candle Light, Fireworks, Red Carpet and Welding) and Stop Program. Using the Up/Down arrows you can select one of the 10 auto programs and confirm by pressing ENTER or step back by ESC.

After confirming your preferred Auto Program, you can now adjust speed and brightness at level 4.

To adjust speed, please use the UP / DOWN arrows to select the menu item "Speed", and confirm with ENTER. After use UP / DOWN arrows to adjust the speed value between 000-100 and confirm by ENTER or jump back by ESC.

To adjust brightness please select "Dim" as per the procedure previously described and confirm with ENTER. After use UP / DOWN arrows again to adjust the brightness value between 000-100 and confirm by ENTER or jump back by ESC.

Once it's confirmed or denied the display will automatically jump back to level 3.

To stop running a selected auto program please chose "Stop Program" at level 3 or "Stop Stand Alone" at level 2.

For returning back to homescreen please press ESC three times.

At homescreen the selected Stand Alone mode "Auto" and the selected program will be displayed.

#### ⓘ \*Note:

Using arrows UP /DOWN at homescreen Auto programs can be directly changed according to the list.

Level 1

Menu
DMX Mode
➔ Stand Alone
Settings
System Info

Level 2

Stand Alone Mode
Stop Stand Alone
➔ Auto
Editor
Color Macro
Quick Color
Tunable White
User Color
Timer
Color Settings

Level 3

Auto
➔ Stop Program
7-Color Fade
7-Color Jump
15-Color Fade
15-Color Jump.....
Police RB
Police B
Candle Light
Fireworks
Red Carpet
Welding

Level 4

Program
➔ Speed <0-100>
<b>(Default 50)</b>
Dim <0-100>

## Auto 7-Color Fade

### Editor\*

At Editor you have up to three customizable programs which can be defined and run from the menus.

Each of the three values contains twenty four user-definable scenes with its own values for RGBALC (RAW) or RGB (Calibrated) and shutter, playing continuously in a loop. Each scene has a definable fade-in time for the transition from one color to the other and wait-time.

To define a program please press ENTER to access to main menu (level 1).

While using the UP / DOWN arrows, please select the menu item "Stand Alone" and confirm by pressing ENTER.

Level 1

Menu
DMX Mode
➔ Stand Alone
Settings
System Info

Level 2

Stand Alone Mode
Stop Stand Alone
Auto
➔ Editor
Color Macro
Quick Color
Tunable White
User Color
Timer
Color Settings

Select "Editor" by using the up/down arrows and press ENTER.

Here at sub-menu (level 3) you can choose between Program 1-3, Dimmer and Stop Program.

Using the Up/Down arrows you can select program 1, 2 or 3 and confirm by pressing ENTER or step back by ESC.

After confirming your preferred program, you can now choose between Scene 1-24.

Select one of the scenes and press ENTER or step back by ESC.

At level 5 you can now set your color, shutter and fade / wait time in minutes and seconds. For creating a color jump please set value for "Fade Time" to 0, and "Wait Time" to at least 1 second.

Once it's set your first scene is programmed.

You can now jump back to level 3 by using ESC. Here your program will start automatically.

For creating more scenes please use the same procedure.

To stop an active program please press ESC and select "Stop Program" at level 3 or "Stop Stand Alone" at level 2.

To start again, please re-select your preferred program, it will start automatically again.

To adjust the master brightness for program 1-3, you can use the item "Dimmer" at level 3 and select between 000-100 and confirm by ENTER or jump back by ESC.

**ⓘ \*Note: Once "Factory Calibration" is selected under "Color Settings" inside Stand Alone, only values for RGB are available here.**

**Using UP / DOWN arrows at homescreen Editor program can be directly changed according to the list.**

**For choosing the right strobe effect please follow the Strobe Channel from our DMX chart at the end of this manual.**

Level 3

Editor
Program 1
➤ Program 2
Program 3
Dim <0-100>
Stop Program

Level 4

Program
➤ Scene 1
Scene 2
Scene 3
...max. 24 Scenes

Level 5

Scene
Red <0-255>
Green <0-255>
Blue <0-255>
Amber <0-255>
Lime <0-255>
Cyan <0-255>
Shutter <0-255>
Fade Time (min.) <0-480>
Fade Time (sec.) <0-59>
Wait Time (min.) <0-720>
Wait Time (min.) <0-59>

### Color Macro\*

46 different color macros (34x matched LEE color filters, 6 LED colors and 6 different Whites) are available as presets. For each the brightness can be adjusted separately.

Level 1

Menu
DMX Mode
➤ Stand Alone
Settings
System Info

Level 2

Stand Alone Mode
Stop Stand Alone
Auto
Editor
➤ Color Macro
Quick Color
Tunable White
User Color
Timer
Color Settings

Level 3

Color Macro
Color Off
➤ Color Macros
Color Macro Chart
Dim <0-100>

To select a color macro please press ENTER to access to main menu (level 1). While using the UP / DOWN arrows select the menu item "Stand Alone" and confirm by pressing ENTER. After please select the item "Color Macro" by using the up/down arrows and press ENTER again.

Using UP and DOWN controls, select your desired color preset and confirm with ENTER.

At level 3 you can adjust the brightness for the color preset between 000-100. Confirm by ENTER. For color blackout choose the item “Color Off”.

**Note:** Using UP / DOWN arrows at homescreen Color Macros can be changed according to the list.

Level 4

Gels - Color Macros for Standalone Mode			Gels - Color Macros for Standalone Mode			Gels - Color Macros for Standalone Mode		
Pos.	Gel Name	Color Number	Pos.	Gel Name	Color Number	Pos.	Gel Name	Color Number
1	Red	100% Red LED	17	Jade	LEE 323	33	Special Med Lavender	LEE 343
2	Fire	LEE 019	18	Blue	100% Blue LED	34	Ultimate Violet	LEE 707
3	Medium Red	LEE 027	19	Sky Blue	LEE 068	35	Magical Magenta	LEE 795
4	Primary Red	LEE 106	20	Tokyo Blue	LEE 071	36	Chrysalis Pink	LEE 798
5	Med Amber	LEE 020	21	Light Blue	LEE 118	37	Specia KH Lavender	LEE 799
6	Dark Amber	LEE 022	22	Marine Blue	LEE 131	38	Bulb White	2700K
7	Deep Amber	LEE 104	23	Med Blue	LEE 132	39	Halogen White	3200K
8	Orange	LEE 105	24	Congo Blue	LEE 181	40	Neutral White	4200K
9	Deep Golden Amber	LEE 135	25	Mikkel Blue	LEE 716	41	Daylight White	5600K
10	Yellow	LEE 101	26	Rose Pink	LEE 002	42	Cold White I	6000K
11	Green	100% Green LED	27	Med Pink	LEE 036	43	Cold White II	6300K
12	Lime Green	LEE 088	28	Light Lavender	LEE 052	44	Amber (only if available)	100% Amber LED
13	Moss Green	LEE 089	29	Lavender	LEE 058	45	Lime (only if available)	100% Lime LED
14	LEE Green	LEE 121	30	Magenta	LEE 113	46	Cyan (only if available)	100% Cyan LED
15	Primary Green	LEE 139	31	Mauve	LEE 126			
16	Jas Green	LEE 738	32	Smokey Pink	LEE 127			

**Quick Color\***

The standalone mode “Quick Color” allows a direct adjustment of the single LED colors R, G, B, A, L, C, Dimmer and Shutter.

Level 1

Menu
DMX Mode
Stand Alone
Settings
System Info

Level 2

Stand Alone Mode
Stop Stand Alone
Auto
Editor
Color Macro
Quick Color
Tunable White
User Color
Timer
Color Settings

Level 3

Quick Color
Dimmer <0-100>
Shutter <0-255>
Red <0-255>
Green <0-255>
Blue <0-255>
Amber <0-255>
Lime <0-255>
Cyan <0-255>

To adjust your Quick Color please press ENTER to access to main menu (level 1).

While using the UP / DOWN arrows select the menu item “Stand Alone” and confirm

by pressing ENTER. After please select the item “Quick Color” by using the up/down arrows and press ENTER again.

Using UP and DOWN controls, select your desired color and confirm with ENTER.

After you can adjust the brightness for the color between 000-255 and confirm by ENTER.  
Besides the individual color mix also a master dimmer can be adjusted between 000-100.  
For strobe effects please adjust the Shutter value between 000-255.

**ⓘ \*Note:** Please see detailed explanation for strobe effects inside DMX chart at the end of this manual.  
If “Factory Calibration” is selected in “Color Settings” only R,G,B is available here.  
Using UP/DOWN arrows at homescreen you can change Quick Color’s dimmer value.

### Tunable White\*

The standalone mode “Tunable White” allows the color temperature (CCT) to be adjusted from 2.000K – 10.000K in 100K steps. Besides brightness and shutter also a +/- green and magenta correction is available.

Level 1

Menu
DMX Mode
➤ Stand Alone
Settings
System Info

Level 2

Stand Alone Mode
Stop Stand Alone
Auto
Editor
Color Macro
Quick Color
➤ Tunable White
User Color
Timer
Color Settings

Level 3

Tunable White
CCT <2000K-10.000>
TINT <000> (+/-127)
Dimmer <0-255>
Shutter <0-255>

Starting from home screen press ENTER to access to main menu (level 1).

While using the UP / DOWN arrows select the menu item “Stand Alone” and confirm by pressing ENTER.

After please select the item “Tunable White” by using the up/down arrows and press ENTER again.

Using UP and DOWN controls to select your desired menu item, confirm by ENTER and adjust the desired value by up and down controls and confirm all entries with ENTER.

**ⓘ \*Note:**

#### Tint values

**000** = no function/neutral

**001 - 127** = + green

**-001 to - 127** = - green

**ⓘ \*Note:** Using UP/DOWN arrows at homescreen the selected CCT value can be changed in +/- 100K steps.  
**Shutter:** Please see detailed explanation for strobe effects inside DMX chart at the end of this manual.

### User Color\*

The standalone mode “User Color” allows to store up to 5 customized color presets out of Red, Green, Blue, Amber, Lime and Cyan, brightness and shutter.

Level 1	Level 2	Level 3	Level 4																														
<table border="1"> <thead> <tr> <th>Menu</th> </tr> </thead> <tbody> <tr> <td>DMX Mode</td> </tr> <tr> <td>█ Stand Alone</td> </tr> <tr> <td>Settings</td> </tr> <tr> <td>System Info</td> </tr> </tbody> </table>	Menu	DMX Mode	█ Stand Alone	Settings	System Info	<table border="1"> <thead> <tr> <th>Stand Alone Mode</th> </tr> </thead> <tbody> <tr> <td>Stop Stand Alone</td> </tr> <tr> <td>Auto</td> </tr> <tr> <td>Editor</td> </tr> <tr> <td>Color Macro</td> </tr> <tr> <td>Quick Color</td> </tr> <tr> <td>Tunable White</td> </tr> <tr> <td>█ User Color</td> </tr> <tr> <td>Timer</td> </tr> <tr> <td>Color Settings</td> </tr> </tbody> </table>	Stand Alone Mode	Stop Stand Alone	Auto	Editor	Color Macro	Quick Color	Tunable White	█ User Color	Timer	Color Settings	<table border="1"> <thead> <tr> <th>User Color</th> </tr> </thead> <tbody> <tr> <td>Color 1</td> </tr> <tr> <td>Color 2</td> </tr> <tr> <td>Color 3</td> </tr> <tr> <td>Color 4</td> </tr> <tr> <td>Color 5</td> </tr> </tbody> </table>	User Color	Color 1	Color 2	Color 3	Color 4	Color 5	<table border="1"> <thead> <tr> <th>User Color</th> </tr> </thead> <tbody> <tr> <td>Dimmer &lt;0-100&gt;</td> </tr> <tr> <td>Shutter &lt;0-255&gt;</td> </tr> <tr> <td>Red &lt;0-255&gt;</td> </tr> <tr> <td>Green &lt;0-255&gt;</td> </tr> <tr> <td>Blue &lt;0-255&gt;</td> </tr> <tr> <td>Amber &lt;0-255&gt;</td> </tr> <tr> <td>Lime &lt;0-255&gt;</td> </tr> <tr> <td>Cyan &lt;0-255&gt;</td> </tr> </tbody> </table>	User Color	Dimmer <0-100>	Shutter <0-255>	Red <0-255>	Green <0-255>	Blue <0-255>	Amber <0-255>	Lime <0-255>	Cyan <0-255>
Menu																																	
DMX Mode																																	
█ Stand Alone																																	
Settings																																	
System Info																																	
Stand Alone Mode																																	
Stop Stand Alone																																	
Auto																																	
Editor																																	
Color Macro																																	
Quick Color																																	
Tunable White																																	
█ User Color																																	
Timer																																	
Color Settings																																	
User Color																																	
Color 1																																	
Color 2																																	
Color 3																																	
Color 4																																	
Color 5																																	
User Color																																	
Dimmer <0-100>																																	
Shutter <0-255>																																	
Red <0-255>																																	
Green <0-255>																																	
Blue <0-255>																																	
Amber <0-255>																																	
Lime <0-255>																																	
Cyan <0-255>																																	

To define a User Color please press ENTER to access to main menu (level 1).

While using the UP / DOWN arrows, please select the menu item “Stand Alone” and confirm by pressing ENTER.

Select the item menu “User Color” by using the up/down controls and press ENTER.

Using UP and DOWN select your desired preset number (Color 1 -5) and confirm with ENTER.

Use UP and DOWN controls to select your desired color, confirm by ENTER and adjust the value by up and down controls between 000-255 and confirm all entries with ENTER.

With dimmer you can adjust the allover brightness of your User Color. Shutter allows several strobe effects. Once your color mix is ready, jump back by ESC. Your individual color is stored under the selected color preset now.

**ⓘ \*Note: All five User Colors are also available by DMX at Color Macro channel. Using one of the RGB DMX modes, only User Colors mixed out of RGB values are available. For Direct modes, both RGB and RGBALC User Colors are available. For detailed information please see Color Macro Chart at the end of this manual. Using UP/DOWN arrows at homescreen the Color Macros can be changed according to the list.**

**Shutter: Please see detailed explanation for strobe effects inside DMX chart at the end of this manual.**

### Timer\*

Via the internal timer function, all Stand Alone modes except "Auto" and "Editor" can be conveniently faded in and out after the function is enabled in the previously activated standalone mode, without the need for an external controller. Also it remains active even the fixture is switched off and restarted. Simultaneously, the timer function is available via cable as well as via wireless DMX for master & slave operation. The fade-in time can be set from 0 to 60 minutes, the dwell time from 1 to 24 hours and the fade-out time from 0 to 60 minutes.

To select “Timer” please press ENTER to access to main menu (level 1). While using the UP / DOWN arrows, please select the menu item “Stand Alone” and confirm by pressing ENTER.

Level 1

Menu
DMX Mode
➤ Stand Alone
Settings
System Info

Level 2

Stand Alone Mode
Stop Stand Alone
Auto
Editor
Color Macro
Quick Color
Tunable White
User Color
➤ Timer
Color Settings

Level 3

Timer
Timer <On / Off>
Fade In <0-60 min> 1 minute steps
Dwell Time <1-24h> 1 hour steps
Fade Out <0-60 min> 1 minute steps

Select the item menu "Timer" by using the up/down controls and press ENTER. Now you can activate / deactivate the Timer function, select "Fade In", "Dwell Time" or "Fade Out" for the individual settings and confirm with ENTER. In each case a three-digit number field will be displayed. Use UP and DOWN to set the value as required from 000 to 060 minutes for "Fade In" and "Fade Out", or 001 to 024 hours for the "Dwell Time". Confirm by pressing ENTER again. After all time settings have been configured, please activate the timer function by selecting the submenu item "Timer On/Off" using UP and DOWN, confirm with ENTER, select "On" and confirm with ENTER again. To disable the timer function, please select "Off" and confirm by ENTER.

ⓘ **\*Note: Please don't forget to select one of the Stand Alone modes for "Startup Mode" at "Settings".**

### Color Settings\*

Here at "Color Settings" you can chose your preferred working color mode for all Stand Alone color modes. Either Factory Calibrated or RAW. Factory color calibration of R, G, B, A, L and C for a maximum of color consistency from unit to unit. Please note If this function is activated only RGB is available at User Color and Quick Color. For a maximum of saturation please chose RAW mode.

Level 1

Menu
DMX Mode
➤ Stand Alone
Settings
System Info

Level 2

Stand Alone Mode
Stop Stand Alone
Auto
Editor
Color Macro
Quick Color
Tunable White
User Color
Timer
➤ Color Settings

Level 3

Color Settings
➤ Factory Calibrated
RAW

## 5.4.5 Settings

Level 1

Menu
DMX Mode
Stand Alone
▀ Settings
System Info

Main Menu	Menu level 2	Menu level 3	Menu level 4	Description
Settings	Wireless DMX (only available if optional CRMX PCB installed)	CRMX	<on/off>	On=CRMX enabled / Off= CRMX disabled
		Operating Mode	<receive/transmit>	Receive= CRMX module as Receiver Transmit= CRMX module as Transmitter
		Transmit Link	<no/yes>	Yes= pair with CRMX devices. CRMX must be activated on all devices and the pairing must be picked up by a transmitter (Receive Reset). No= Linking disabled
		Receive Reset	<no/yes>	Yes = retain transmitter pairing No = do not retain transmitter pairing
		Pass to DMX Out	<no/yes>	Yes= incoming wireless DMX and BLE signal will be passed to wired DMX out No= incoming wireless DMX and BLE signal will not be passed to wired DMX out
		Signal Strength	0-100	CRMX signal strength
		BLE	<on/off>	On= BLE enabled / Off= BLE disabled
		BLE Password	<000000>	Set 6-digits user Password for connection to your mobile device (ROXXAPP)
	Protocol	DMX		
		Slave		
	Display	Backlight	<on/off>	On= controls permanent on, display itself will deactivate after 60 minues of incativity Off= controls and display deactivation after approximately 1 minute of inactivity
		Auto Lock	<on/off>	On= Automatically locks the controls after approximately 1 minute of inactivity. After attempted input the display shows: „Locked!“ Unlock process: press arrows up, down, up, down consecutively
	Startup Mode (using last adjustments of specific Standalone Modes)	<b>Hold</b> (factory default)		Select your default operating mode when fixture is powered on
		DMX		
		Auto		
		Editor		
		Color Macro		
		Quick Color		
		Tunable White		
		User Color		
	DMX Fail	<b>Hold</b> (factory default)		Hold= last command retains, also after power cycle
		Blackout		Blackout= Activates Blackout
	DMX Fail	Emergency Light		Emergency Light= Fixtures changes to 5600K
Knobs			Fixture runs according to backside knobs for dimmer and CCT/Color	

Main Menu	Menu level 2	Menu level 3	Menu level 4	Description
Settings	Dimmer Curve	<b>Linear</b>		Linear= Light intensity increases linear with DMX value
		Exponential		Exponential= Light intensity can be set more smooth at lower DMX values and broadly at higher DMX values.
		Logarithmic		Light intensity can be broadly adjusted at lower DMX values and more smooth at higher DMX values
		S-Curve		Light intensity can be adjusted smoothly at lower and higher DMX values and broadly at medium DMX values
	Dimmer Response	<b>LED</b>		The LED responds abruptly to it's DMX values
		Halogen		The LED responds similar to a halogen fixture with soft changes at brightness.
	Color Calibration	<b>Normal CRI</b>	Colors & CCT calibrated, normal CRI mode	
		High CRI	Colors & CCT calibrated, high CRI mode	
	RAW Balance (affects RAW Mode in DMX and Stand-alone control)	User Calibration	Red <0-255>	Individual color calibration for R,G,B,A,L and C
			Green <0-255>	
			Blue <0-255>	
			Amber <0-255>	
			Lime <0-255>	
			Cyan <0-255>	
	LED Frequency	800 Hz	Select preferred LED PWM frequency	
		<b>1200 Hz</b>		
		2000 Hz		
		3600 Hz		
		12000 Hz		
		25000 Hz		
	Fan	<b>Auto 1</b>		Adjust fan speed relative to internal fixture temperature, maximum 2360rpm
		Auto 2		Adjust fan speed relative to internal fixture temperature, maximum 2000rpm
		Silent 1		Constant 1600 rpm and max. 10% drop @25°C ambient temperatur
		Silent 2		Low fan speed for silent operation, constant 1350 rpm and max. 10% drop @25°C ambient temperature
		Studio		Low fan speed for silent operation, constant 1070 rpm and max. 10% drop @25°C ambient temperatur
		Fan Off		Fan Off and max. 10% drop @25°C ambient temperature
		Max Power		High fan speed for maximum cooling effect, constant 3000rpm
		Redshift	On / <b>Off</b>	On= Activates Redshift, Off= Deactivates Redshift

Main Menu	Menu level 2	Menu level 3	Menu level 4	Description	
Settings	USB Update	Auto		Runs firmware update automatically, once USB stick gets plugged in	
		<b>Manual</b>			
	USB Update	No		Do not run firmware update via USB port	
	KLSTR switch	On / <b>Off</b>		makes it possible to switch KLSTR.nano off for update	
	Factory / User Reset	For more and detailed information about the different reset options please refer to chapter "5.4.6.1 Reset functions"	Factory Reset	Are you sure to reset? / Confirm by pressing ENTER, cancel with ESC	Restores all factory defaults , but not User defaults and no User Colors
			User Reset	Are you sure to reset? / Confirm by pressing ENTER, cancel with ESC	Restores all User Reset according to the User Preset List. User Colors will not set back. Timer Function and DMX adress restore to Factory default. Once User Reset is activated a fixture self test will start. Self Test is not available while activating User Rest by DMX Settings.
			User Reset List	DMX Mode. 1CH Quick 4CH CCT, 7CH CCT, 6CH RGB, 11CH RGB, 15CH RGB, 12CH DIRECT, 14CH DIRECT, 21CH DIRECT, 6CH HSI, 12CH HSI	Select your User Reset defaults
				CRMX <on/off>	
				CRMX Operating Mode. <receive/transmit>	
				CRMX Receive Reset <no/yes>	
				BLE <on/off>	
				BLE Link <no/yes>	
				CRMX Pass to DMX Out <no/yes>	
				Backlight <on/off>	
				Auto Lock <on/off>	
				Startup Mode <DMX/ Auto/Editor/Color Macro, Quick Color, Tunable White, User Color, Knobs>	
				DMX Fail <Hold/Black-out/Emergency, Knob>	
				Dimmer Curve <Linear, Exponential, Logarithmic, S-Curve>	
				Dimmer Response <LED, Halogen >	
				Color Calibration <Normal CRI / High CRI>	
				RAW Balance <RAW / User Calibration>	
				LED Frequency <800Hz, <b>1200Hz</b> , 2000Hz, 3600Hz, 12000Hz, 25000Hz>	
				Fan < <b>Auto1</b> , Auto 2, Silent 1,Silent 2, Studio, Fan Off, Max Power>	
					Redshift <on/off>

## Dimmer Curves

Linear

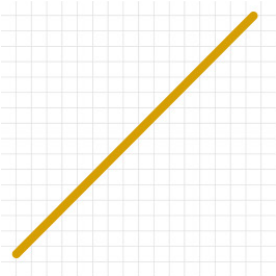

Exponential

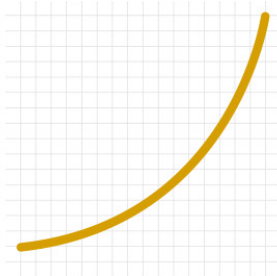

Logarithmic

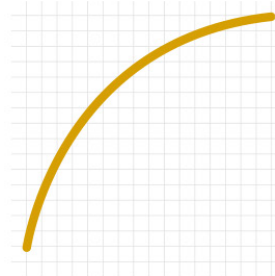

S-Curve

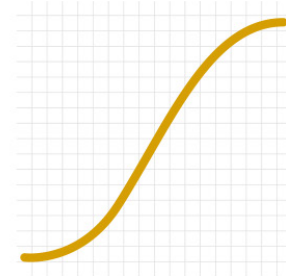

### 5.4.5.1 Reset Functions

#### 1. Via DMX

Factory / User Reset only starts if shutter channel has the DMX value “250” at the same time

- ⊖ Factory Reset:  
DMX address and DMX mode stay on the same value as set before the reset
- ⊖ User Reset:  
DMX address and DMX mode stay on the same value as set before the reset  
There is no LED / Fan test

#### 2. Via RDM

Factory / User Reset only starts if shutter channel has the DMX value “250” at the same time

- ⊖ Factory Reset:  
DMX address and DMX mode stay on the same value as set before the reset
- ⊖ User Reset:  
DMX address and DMX mode stay on the same value as set before the reset

There is no LED / Fan test

#### 3. Via Menu / Display Shortcut

- ⊖ Factory Reset:  
Display Query:  
“> With Add. / Mode  
No Add. / Mode  
RESET NOW?”
- ⊖ If “With Add. / Mode” is selected, DMX address is set to “1” and DMX mode changes to default mode
- ⊖ If “No Add. / Mode” is selected, DMX address and DMX Mode stay at current values

⊖ User Reset:

Display Query:

**"> With Add. / Mode  
No Add. / Mode  
RESET NOW?"**

⊖ If "With Add. / Mode" is selected, DMX address is set to "1" and DMX mode changes to the mode defined by "User Reset List / DMX Mode"

⊖ If "No Add. / Mode" is selected, DMX address and DMX Mode stay at current values

Unit Starts LED / Fan test.

### 5.4.6 System Info

Level 1

Menu
DMX Mode
Stand Alone
Settings
➔ System Info

Main Menu	Menu level 2	Menu level 3	Menu level 4
System Info	Firmware Version	Fixture: VX.XX	Display installed firmware version
		KLSTR: VX.XX	
	Serial Number	210xxxxxxxx	
	RDM UID	Fixture: 0x6a6axxxxxxxxx	Display unique RDM ID for identification
		KLSTR: xxxxxxxxxxxxxxx	
	Temperatures	Celsius      LED : XXX°C or Fahrenheit    LED : XXX °F	Display fixture temperature by celsius and fahrenheit
	Power on Time	Total: xxxxxhours	Display fixture total power on time
	LED on Time	Total: xxxxxhours	Display LED total power on time
Errors	Errors information	Display error codes	

## 6. ACCESSORIES



The revolutionary advanced 8-Way Barndoor redefines light shaping. In addition to the classic design with eight blades, two blades can be rotated along the X-axis to correct slanted distortions and transform them into a straight edge, enabling a new level of precision. Whether you need precise light control, subtle shading, or creative shaping, this flexible system adapts to any lighting scenario. If you need a stable x-axis, tighten the setscrew on the back of the barndoor.

An integrated grid holder further improves control. For example, glare in the front rows of the audience can be avoided by using single or double grids for partial light reduction (grid S 30% D 60%) and sophisticated light graduations – perfect for TV, cinema, or theater applications.

### 6.1 More accessories



Barndoor black  
Art.: 15908101



Gel Frame  
Art.: 15908501

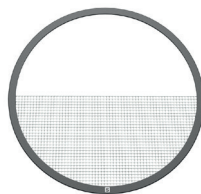

Half Grid S, black  
Art.: 15908301

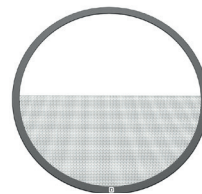

Half Grid D, black  
Art.: 15908401



Tracklight-Kit  
Art.: 15904201

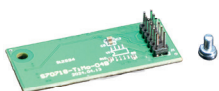

TimoTwo Modul  
Art.: 15900100

## 7. TECHNICAL DATA / DIAGRAMS

### 7.1 Technical drawings and measurements

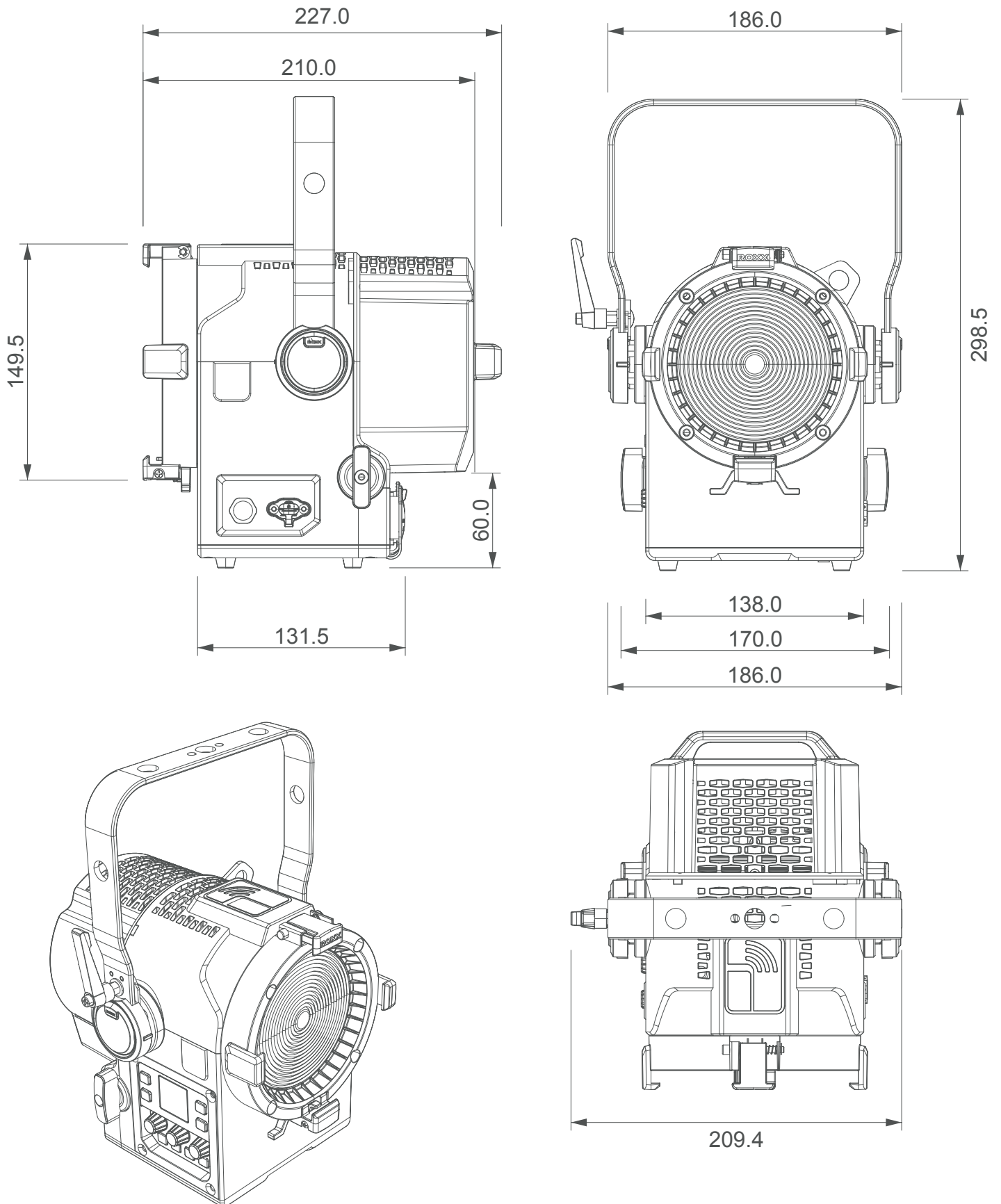

## 7.2 IP Rating

ROXX products conform to officially classified IP standard levels. ICON F4is rated to IP65 when using the covers for the housing parts. IP stands for Ingress Protection and IP65, according to classified standard, means shielded against dust and high-pressure jets of water from any side.

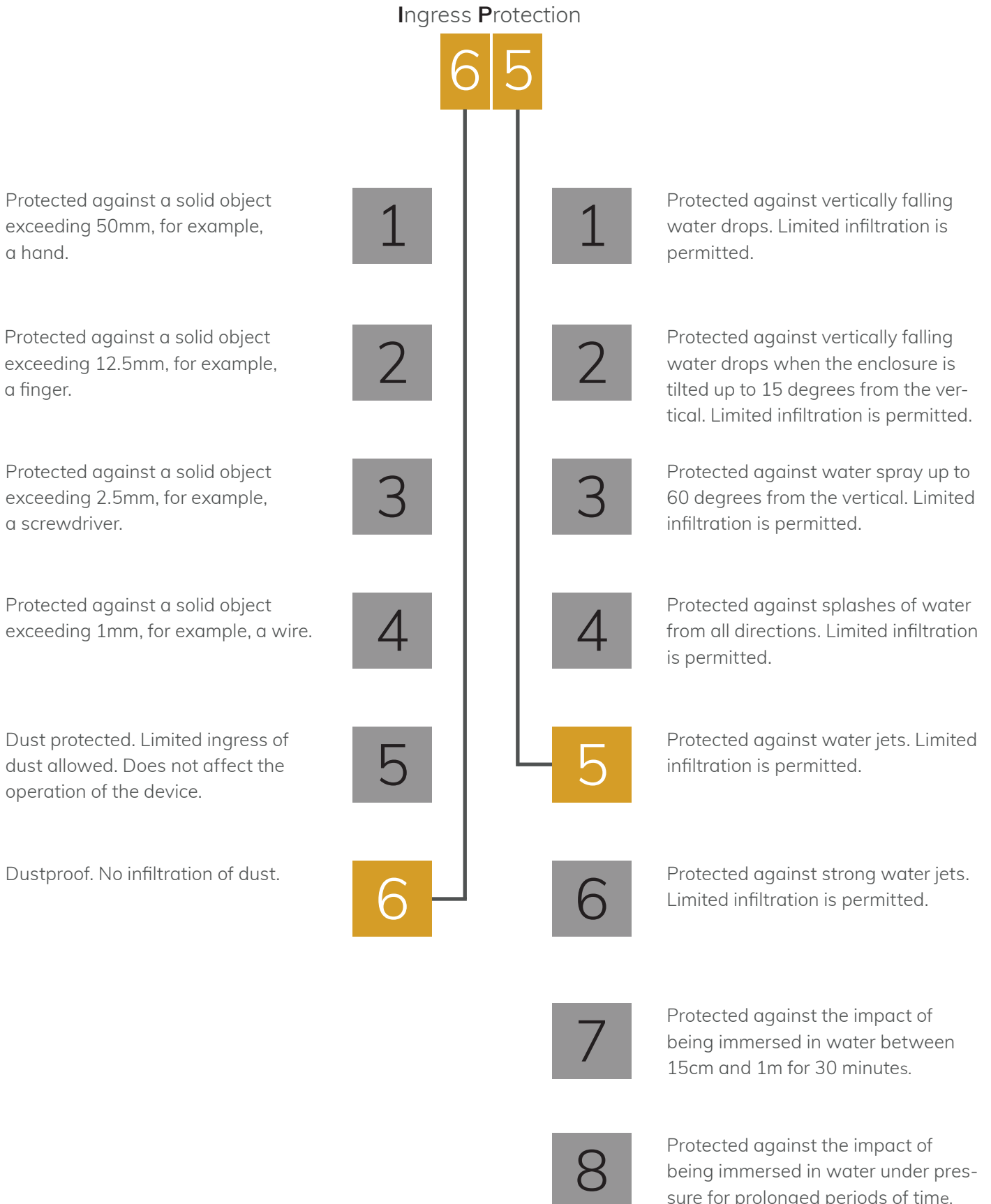

### 7.3 Technical Data

Photometrics	
LED expected lifetime	50.000 hours
Lightsource	200W RGBALC
Type of optical system	Fresnel lens 4" with manual zoom
LED PWM Frequency	selectable 800Hz, 1.200Hz, 2.000Hz, 3.600Hz, 12kHz, 25kHz
Beam angles @ narrow (50%)	18,1°
Maximum Field angles @ narrow (10%)	31,7°
Beam angles @ wide (50%)	75,2°
Maximum Field angles @ wide (10%)	103°
Color temperature range	2000-10.000K
CRI/Ra	up to 98
TLCI	up to 99
Luminous flux @ 5600K (High CRI) narrow / wide	1776 lm / 3135 lm
illuminance Lux @ 5m / 16,4ft (@ 5600K High CRI) narrow / wide	636 lx / 94 lx
Efficacy @ Full (max)	31 lm/W
Dimensions & Weight	
IP class	IP65
IK class	IK08
Body material	Aluminum, Nylon
Lens material	Plastic
Net dimensions incl.Yoke mm (w x h x d)	209,04 x 298,50 x 227,00 mm
Net dimensions incl. Yoke inches (w x h x d)	8,23 x 11,75 x 8,94 inch
Net dimensions without Yoke mm (w x h x d)	170,0 x 209,5 x 227,00mm
Net dimensions without. Yoke inches (w x h x d)	6,69 x 8,25 x 8,94 inch
Net weight (without Barndoors)	3,9 kg / 8,59lbs
Net weight (including Barndoors)	5,0 kg / 11,02lbs
Thermal Characteristics	
Cooling	Active, Heatpipe-System, Temperature-regulated
Humidity (max.)	95%
Temperature range, AC Operating	-40°C to 45°C
Temperature range, Start-Up AC Operating	-20° to 45°C
Temperature range, Storage AC only	-40°C to 80°C
Temperature range, Battery Operating	-20° to 40°C
Temperature range, Start-Up Battery Operating	-20° to 40°C
Temperature range, Storage Battery	-10°C to 25°C
Temperature range, Charging	0°C to 40°C
Thermal Protection	Automatic overtemperature protection

### 7.3 Technical Data

Electrical Data	
AC Power, max	100 – 240V 50/60Hz
AC Power, nominal	100 – 240V 50/60Hz
Electrical protection	Overload protection with automatic recover
Power Max. Out	108W @ 100V / 103W @ 230V
Power Linking	12 units @ 120V / 24 units @ 230V
Power Factor	PF 1@ 100V / PF 0.99 @ 230V
Standby Power	3,5W
Power Thru max. @ 100V	10A (ETL) / 13A
Power Thru max. @ 230V	11A (ETL) / 14A
Power Supply Unit	Inbuilt auto-ranging electronic switch-mode
Included / optional	
Included items	8-way Barndoor, 2m Power Cable
Optional Accessories	Gel Frame, Grids (Double and Single), Tracklight Adapter
Color options	Black – RAL 9004 (Standard) Custom color – any RAL (on request)
Operator & Controller	
DMX channels	1CH QUICK, 4CH CCT, 7CH CCT, 6CH RGB, 10CH RGB, 18CH RGB, 12CH DIRECT, 14CH DIRECT, 21CH DIRECT, 6CH HSI, 12CH HSI
DMX modes	11
Protocol	USITT DMX512A RDM ANSI E1.20 optional: CRMX, W-DMX™ G2, W-DMX™ G3, W-DMX™ G4, W-DMX™ G4S optional: Bluetooth (Low Energy) KLSTR technology ready
Setting and addressing	TFT Display RDM ANSI E1.20 Near Field Control (NFC)
Standalone mode	Auto Program, Color Macro, Quick Color, Tunable White, User Color
Wireless DMX & Bluetooth	optional: Lumen Radio transmitt & receive function (CRMX)
indicator	TFT display
controls	8 backlighted controls
Strobe	0-30Hz
DMX I/O	IP65 XLR 5-pin male/female
Power In	TRUE1 compatible input & link-thru sockets
USB Firmware Update	IP65 USB-C socket / USB update box
Installation	
Orientation	Any
Rigging possibilities	hanging direct
Safety features	1x safety eye
Minimum distance from flammable materials	0,3 meters (11,8 inch)

## 7.4 DMX-Charts / Color Macro Charts / CCT Chart

<b>1CH Quick</b>				
<b>4CH CCT</b>	<b>6CH RGB</b>	<b>18CH RGB / Default</b>	<b>14CH DIRECT</b>	<b>6CH HSI</b>
<b>7CH CCT</b>	<b>10CH RGB</b>	<b>12CH DIRECT</b>	<b>21CH DIRECT</b>	<b>12CH HSI</b>

Here you can find the DMX charts for the ICON F4 for reading or downloading. Simply click on the icon or scan the QR code.

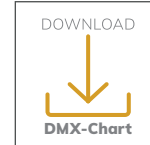

### Color Macro Chart

Gels - Color Macros for DMX		
DMX value	Gel Name	Color Number
000-005	no function	
006-008	Red	100% Red LED
009-011	Fire	LEE 019
012-014	Medium Red	LEE 027
015-017	Primary Red	LEE 106
018-020	Med Amber	LEE 020
021-023	Dark Amber	LEE 022
024-026	Deep Amber	LEE 104
027-029	Orange	LEE 105
030-032	Deep Golden Amber	LEE 135
033-035	Yellow	LEE 101
036-038	Green	100% Green LED
039-041	Lime Green	LEE 088
042-044	Moss Green	LEE 089
045-047	LEE Green	LEE 121
048-050	Primary Green	LEE 139
051-053	Jas Green	LEE 738
054-056	Jade	LEE 323
057-059	Blue	100% Blue LED
060-062	Sky Blue	LEE 068
063-065	Tokyo Blue	LEE 071
066-068	Light Blue	LEE 118
069-071	Marine Blue	LEE 131
072-074	Med Blue	LEE 132
075-077	Congo Blue	LEE 181
078-080	Mikkel Blue	LEE 716
081-083	Rose Pink	LEE 002
084-086	Med Pink	LEE 036
087-089	Light Lavender	LEE 052
090-092	Lavender	LEE 058

Gels - Color Macros for DMX		
DMX value	Gel Name	Color Number
093-095	Magenta	LEE 113
096-098	Mauve	LEE 126
099-101	Smokey Pink	LEE 127
102-104	Special Med Lavender	LEE 343
105-107	Ultimate Violet	LEE 707
108-110	Magical Magenta	LEE 795
111-113	Chrysalis Pink	LEE 798
114-116	Specia KH Lavender	LEE 799
117-119	Bulb White	2700K
120-122	Halogen White	3200K
123-125	Neutral White	4200K
126-128	Daylight White	5600K
129-131	Cold White I	6000K
132-134	Cold White II	6300K
135-137	White (only if available)	100% White LED
138-140	Amber (only if available)	100% Amber LED
141-143	Lime (only if available)	100% Lime LED
144-146	Cyan (only if available)	100% Cyan LED
147-149	User Color 1	
150-152	User Color 2	
153-155	User Color 3	
156-158	User Color 4	
159-161	User Color 5	
162-164	Color Jumping stop	
165-209	Color Jumping speed slow @ fast	color 1-37
210-255	Color fading speed slow @ fast	color 1-37

## Color Macro Chart

Gels - Color Macros for Standalone Mode		
Position	Gel Name	Color Number
1	Red	100% Red LED
2	Fire	LEE 019
3	Medium Red	LEE 027
4	Primary Red	LEE 106
5	Med Amber	LEE 020
6	Dark Amber	LEE 022
7	Deep Amber	LEE 104
8	Orange	LEE 105
9	Deep Golden Amber	LEE 135
10	Yellow	LEE 101
11	Green	100% Green LED
12	Lime Green	LEE 088
13	Moss Green	LEE 089
14	LEE Green	LEE 121
15	Primary Green	LEE 139
16	Jas Green	LEE 738
17	Jade	LEE 323
18	Blue	100% Blue LED
19	Sky Blue	LEE 068
20	Tokyo Blue	LEE 071
21	Light Blue	LEE 118
22	Marine Blue	LEE 131
23	Med Blue	LEE 132
24	Congo Blue	LEE 181
25	Mikkel Blue	LEE 716
26	Rose Pink	LEE 002
27	Med Pink	LEE 036
28	Light Lavender	LEE 052

Gels - Color Macros for Standalone Mode		
Position	Gel Name	Color Number
29	Lavender	LEE 058
30	Magenta	LEE 113
31	Mauve	LEE 126
32	Smokey Pink	LEE 127
33	Special Med Lavender	LEE 343
34	Ultimate Violet	LEE 707
35	Magical Magenta	LEE 795
36	Chrysalis Pink	LEE 798
37	Specia KH Lavender	LEE 799
38	Bulb White	2700K
39	Halogen White	3200K
40	Neutral White	4200K
41	Daylight White	5600K
42	Cold White I	6000K
43	Cold White II	6300K
44	White (only if available)	100% White LED
45	Amber (only if available)	100% Amber LED
46	Lime (only if available)	100% Lime LED
47	Cyan (only if available)	100% Cyan LED

CTC channel  
DMX / Color temperature

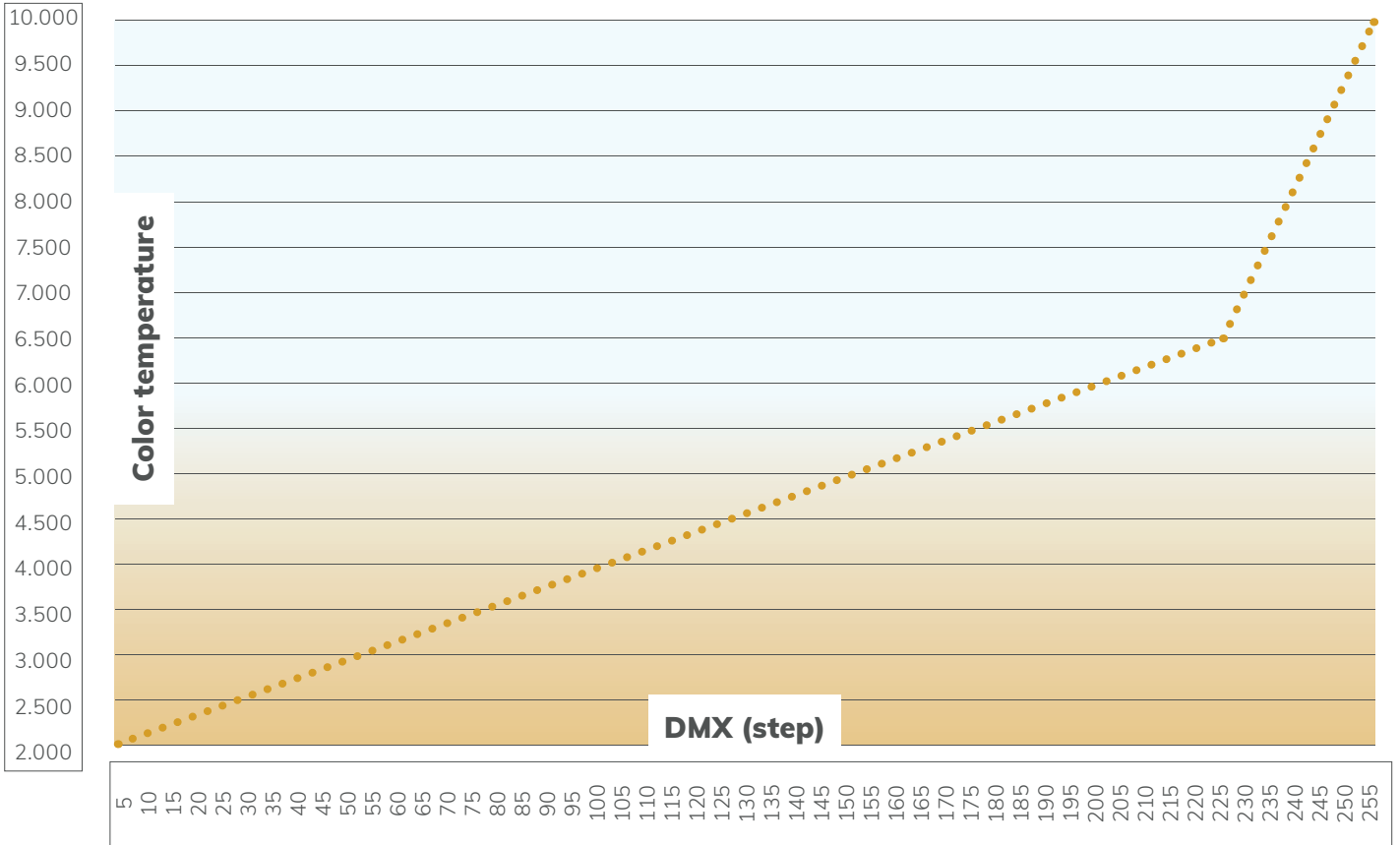

CTC-Chart

DMX (Step)	Color Temp (°K)	DMX (Step)	Color Temp (°K)	DMX (Step)	Color Temp (°K)	DMX (Step)	Color Temp (°K)	DMX (Step)	Color Temp (°K)	DMX (Step)	Color Temp (°K)
0	5600	43	2774	86	3649	129	4525	172	5400	215	6276
1	5600	44	2794	87	3670	130	4545	173	5421	216	6296
2	5600	45	2814	88	3690	131	4566	174	5441	217	6317
3	5600	46	2835	89	3710	132	4586	175	5462	218	6337
4	5600	47	2855	90	3731	133	4606	176	5482	219	6357
5	2000	48	2876	91	3751	134	4627	177	5502	220	6378
6	2020	49	2896	92	3771	135	4647	178	5523	221	6398
7	2041	50	2916	93	3792	136	4667	179	5543	222	6419
8	2061	51	2937	94	3812	137	4688	180	5563	223	6439
9	2081	52	2957	95	3833	138	4708	181	5584	224	6459
10	2102	53	2977	96	3853	139	4729	182	5604	225	6480
11	2122	54	2998	97	3873	140	4749	183	5624	226	6500
12	2143	55	3018	98	3894	141	4769	184	5645	227	6621
13	2163	56	3038	99	3914	142	4790	185	5665	228	6741
14	2183	57	3059	100	3934	143	4810	186	5686	229	6862
15	2204	58	3079	101	3955	144	4830	187	5706	230	6983
16	2224	59	3100	102	3975	145	4851	188	5726	231	7103
17	2244	60	3120	103	3995	146	4871	189	5747	232	7224
18	2265	61	3140	104	4016	147	4891	190	5767	233	7345
19	2285	62	3161	105	4036	148	4912	191	5787	234	7466
20	2305	63	3181	106	4057	149	4932	192	5808	235	7586
21	2326	64	3201	107	4077	150	4952	193	5828	236	7707
22	2346	65	3222	108	4097	151	4973	194	5848	237	7828
23	2367	66	3242	109	4118	152	4993	195	5869	238	7948
24	2387	67	3262	110	4138	153	5014	196	5889	239	8069
25	2407	68	3283	111	4158	154	5034	197	5910	240	8190
26	2428	69	3303	112	4179	155	5054	198	5930	241	8310
27	2448	70	3324	113	4199	156	5075	199	5950	242	8431
28	2468	71	3344	114	4219	157	5095	200	5971	243	8552
29	2489	72	3364	115	4240	158	5115	201	5991	244	8672
30	2509	73	3385	116	4260	159	5136	202	6011	245	8793
31	2529	74	3405	117	4281	160	5156	203	6032	246	8914
32	2550	75	3425	118	4301	161	5176	204	6052	247	9034
33	2570	76	3446	119	4301	162	5197	205	6072	248	9155
34	2590	77	3466	120	4342	163	5217	206	6093	249	9276
35	2611	78	3486	121	4362	164	5238	207	6113	250	9397
36	2631	79	3507	122	4382	165	5258	208	6133	251	9517
37	2652	80	3527	123	4403	166	5278	209	6154	252	9638
38	2672	81	3548	124	4423	167	5299	210	6174	253	9759
39	2692	82	3568	125	4443	168	5319	211	6195	254	9879
40	2713	83	3588	126	4464	169	5339	212	6215	255	10000
41	2733	84	3609	127	4484	170	5360	213	6235		
42	2753	85	3629	128	4505	171	5380	214	6256		

## 7.5 RDM Templates\*

The ROXX Show series features support for various RDM functions.

RDM (Remote Device Management) is a protocol enhancement to USITT DMX512 that allows bi-directional communication between the fixtures and the controller over a standard DMX line. This protocol will allow configuration, status monitoring and management. You will need a RDM controller to get control over the supported parameters. See the tables below for supported RDM features.

Label:	ROXX ICON F4
Model:	ICON F4
Manufacturer:	ROXX
ID:	6A6Ah
Device ID:	210 xxxx

**\*Note: During RDM identifying process ICON F4 flashes white to blue color alternately.**

### RDM functions

For easy identifying ROXX ICON F4 during RDM process the unit will jump from white color to blue color every second.

PID	Function	Action	Values
0x00F0	DMX Start Address	Set	001-512
0x00E0	DMX Personality	Set	DMX modes
0x0120	DMX Slots	Read	
0x0090	Factory Defaults	Set	
0x8062	Protocol	Set	1= DMX / 2= Slave
0x0500	Display Invert	Set	0= Off / 1= On
0x0501	Display Backlight	Set	0= Off / 1= On
0x0641	Display Lock	Set	0= Off / 1= On
0x8018	CRMX Operating Mode	Set	1= RX / 0= TX
0x8019	CRMX Receive Reset	Set	0= No / 1= Yes
0x801A	CRMX Transmit Link	Set	0= No / 1= Yes
0x801B	CRMX Pass to DMX out	Set	0= No / 1= Yes
0x801C	Bluetooth	Set	0= Off / 1= On
0x801D	Bluetooth Link	Set	0= No / 1= Yes
0x0142	Startup Mode	Set	1= Hold / 2= DMX / 3= Auto / 4= Editor / 5= Color Macro / 6= Quick Color / 7= Tunable White / 8= User Color / 9= Knobs
0x0141	DMX Fail	Set	1= Hold / 2= Blackout / 3= Emergency Light / 4= Knobs
0x0343	Dimmer Curve	Set	1= Linear / 2= Exponential / 3= Logarithmic / 4= S-Curve
0x0344	Dimmer Curve Description	Read	
0x0345	Dimmer Response	Set	1= LED / 2= Halogen
0x0346	Dimmer Response Description	Read	
0x0347	LED Frequency (PWM)	Set	1= 800Hz / 2= 1200Hz / 3= 2000Hz / 4= 3600Hz / 5= 12kHz / 6= 25kHz
0x0348	LED Frequency Description	Read	
0x8032	Redshift	Set	0= Off / 1= On
0x805a	Fan Mode	Set	1= Auto 1 / 2= Auto 2 / 3= Silent 1 / 4= Silent 2 / 5= Studio / 6= Fan Off / 7= Max. Power

0x8060	StandAlone Color Settings	Set	1= Color Calibration / 2= RAW
0x8061	Color Calibration	Set	1= Normal CRI / 2= High CRI
0x8058	RAW Balance	Set	1= RAW / 2= User Calibration
0x8101	User Calibration RED	Set	000-255
0x8102	User Calibration GREEN	Set	000-255
0x8103	User Calibration BLUE	Set	000-255
0x8104	User Calibration AMBER	Set	000-255
0x8105	User Calibration LIME	Set	000-255
0x8106	User Calibration CYAN	Set	000-255
0x1001	Device Reset (New Boot)	Set	0= No / 1= Yes
0x805e	Factory Reset	Set	0= No / 1= Yes
0x805f	User Reset	Set	0= No / 1= Yes
0x00D3	Serial Number	Read	
0x00C0	Boot Software Label	Read	
0x00C1	Boot Software ID	Read	
0x0400	Device Hours	Read	
0x0401	LED Hours	Read	
Sensor 1	LED Temperature	Read	
Sensor 2	Fan Speed	Read	

\* For more and detailed information about the different reset options please refer to chapter "5.4.6.1 Reset functions"

## Sensors

RDM enables various readouts for remote device monitoring. See the table below for sensors and sensor types. Please note: The RDM controller communicates with the fixtures to show only the available sensors for this fixture. The table is subject to change without notice.

Name	
Temperature	xx°C / xxx°F
Software Version	SW-Version
Errors	

## 8. TROUBLESHOOTING

Did you try turning the device off and on again?

Problem	Reason	Solution
Device is not responding.	No power.	Check cable connections and conform that power is switched on.
	Fuse defect.	Contact your qualified service technician / manufacturer.
Device has turned off.	Power failure or power was turned off.	Check power supply, fuse, connections, switches.
Device has stopped responding.	DMX cable correct?	Check cables.
	Wireless connection got cut off.	Check wireless transmitter and connection signals.
Device operates strangely.	DMX cable inverted (pins correct?)	Use a phase inverter or different cables.
	DMX cable terminated?	If not, install DMX termination at the end of the cable.
	Stand Alone program running?	Stop internal Stand Alone.
No Bluetooth Connectivity	No Bluetooth Connectivity	Please make sure your mobile device is inside the connectivity range of maximum 10-15m.
	Bluetooth is disabled at your mobile device	Please enable Bluetooth at your mobile device settings.
	Mobile device has wrong Bluetooth Pin	Please use same Bluetooth Pin to connect ROXX. APP with the fixture. Current BLE Pin can be read out inside fixture's wireless DMX settings.
	Mobile device has different Bluetooth connectivity	As only one Bluetooth connectivity can be active, please make sure your mobile device is currently not connected to some other devices.
	Different mobile device is still connected to the fixture	Please disconnect other mobile device from fixture.
	No Bluetooth Advertisement	Please send new BLE advertisement by enable "BLE Link" inside Settings of the fixture.
	Bluetooth module has hang up	Please enable Factory Reset at the fixture to re-start the Bluetooth module.

## 9. MANUFACTURER'S DECLARATION

### Manufacturer's Warranty & Limitations of Liability

Please find our warranty conditions and limitations of liability inside our manufacturer's declaration at [www.roxxlight.com/support](http://www.roxxlight.com/support)

### Requesting Warranty-Service

To request warranty service for your product, please contact:

ROXX GmbH,

Hansestr. 91, 51149 Köln

Email: [info@roxxlight.com](mailto:info@roxxlight.com) or the ROXX authorized reseller in your country, from where you purchased your product.

### Correct Disposal of this product



This is for the European Union and European countries with electrical waste collection systems. When this label is shown on the product or brochure it means that the item cannot be disposed with household waste. In order to prevent damage to the environment or human health please do not dispose this product uncontrolled. Make sure to act responsible, recycle this product separately from other types of waste to enable lasting reuse of resources. Private users please contact the retailer where you purchased this product or your local authorities to find out where and how proper recycling of this item is possible. Business users please contact your supplier or check the terms and conditions of your purchasing contract. Make sure not to mix this product with other commercial waste.

### FCC Statement

This device complies with Part 15 of the FCC Rules. Operation is subject to the following two conditions:

- (1) This device may not cause harmful interference, and
- (2) This device must accept any interference received, including interference that may cause undesired operation

NOTE: This equipment has been tested and found to comply with the limits for a Class B digital device, pursuant to Part 15 of the FCC Rules. These limits are designed to provide reasonable protection against harmful interference in a residential installation. This equipment generates, uses and can radiate radio frequency energy and, if not installed and used in accordance with the instructions, may cause harmful interference to radio communications. However, there is no guarantee that interference will not occur in a particular installation. If this equipment does cause harmful interference to radio or television reception, which can be determined by turning the equipment off and on, the user is encouraged to try to correct the interference by one or more of the following measures:

- Reorient or relocate the receiving antenna.
- Increase the separation between the equipment and receiver.
- Connect the equipment into an outlet on a circuit different from that to which the receiver is connected.
- Consult the dealer or an experienced radio/TV technician for help.

## CE Compliance

The equipment marketed by ROXX GmbH complies (where applicable) with the essential requirements and other specifications of the following Directives:

- 2014/53/EU (RED)
- 2014/30/EU (EMC)
- 2014/35/EU (LVD)
- 2011/65/EU (RoHS)

The complete EU- and UK-Declaration of Conformity can be found at [www.roxxlight.com/support](http://www.roxxlight.com/support), or you can also request it at [info@roxxlight.com](mailto:info@roxxlight.com)

